

VOLUNTARY PRODUCT ACCESSIBILITY TEMPLATE

Section 508 Information

The Social Security Administration (SSA) considers accessibility to electronic and information technology a priority for all employees and external customers, including individuals with disabilities. The SSA has established these Electronic and Information Technology Accessibility Requirements (EIT) in order to support its obligations, under Sections 504 and 508 of the Rehabilitation Act of 1973, 29 U.S.C. 794 and 794d. This is to ensure the accessibility of its programs and activities to individuals with disabilities, specifically its obligation to acquire accessible electronic and information technology.

SSA's Section 508 Requirements

Addresses the minimum accessibility requirements EIT must meet in order to be used by all SSA employees and members of the public with disabilities. These requirements are offered to demonstrate the accessibility needs that must be considered when designing and developing EIT for the SSA.

SSA's Section 508 Evaluation Template

Provides a checklist for evaluating EIT requirements.



CS-C3232

VOLUNTARY PRODUCT ACCESSIBILITY TEMPLATE

Section 1194.25 Self Contained, Closed Products

Criteria	Supporting Features	Remarks/Explanations
a) Self contained products shall be usable by people with disabilities without requiring an end-user to attach Assistive Technology to the product. Personal headsets for private listening are not Assistive Technology.	Not Applicable	
b) When timed response is required, the user shall be alerted and given sufficient time to indicate more time is required.	Supports with Exceptions	When the “Energy Star” mode is deactivated, there is no timed response required.
c) Where a product utilizes touch screens or contact-sensitive controls, an input method shall be provided that complies with 1194.23 (k) (1) through (4).	Supports with Exceptions	(see sub-sections) (k) 1 to 4
(k) (1) Products which have mechanically operated controls or keys shall comply with the following: Controls and Keys shall be tactilely discernible without activating the controls or keys.	Supports with Exceptions	The number keys have a raised dash on the “5” key.
(k) (2) Products which have mechanically operated controls or keys shall comply with the following: Controls and Keys shall be operable with one hand and shall not require tight grasping, pinching, twisting of the wrist. The force required to activate controls and keys shall be 5 lbs. (22.2N) maximum.	Supports	All controls and keys are operable with one hand and do not require special wrist action or force over 5 lbs.
(k) (3) Products which have mechanically operated controls or keys shall comply with the following: If key repeat is supported, the delay before repeat shall be adjustable to at least 2 seconds. Key repeat rate shall be adjustable to 2 seconds per character.	Not Applicable	
(k) (4) Products which have mechanically operated controls or keys shall comply with the following: The status of all locking or toggle controls or keys shall be visually discernible, and discernible either through touch or sound.	Not Applicable	

VOLUNTARY PRODUCT ACCESSIBILITY TEMPLATE

Criteria	Supporting Features	Remarks/Explanations
d) When biometric forms of user identification or control are used, an alternative form of identification or activation, which does not require the user to possess particular biological characteristics, shall also be provided.	Not Applicable	
e) When products provide auditory output, the audio signal shall be provided at a standard signal level through an industry standard connector that will allow for private listening. The product must provide the ability to interrupt, pause, and restart the audio at anytime.	Not Applicable	
f) When products deliver voice output in a public area, incremental volume control shall be provided with output amplification up to a level of at least 65 dB. Where the ambient noise level of the environment is above 45 dB, a volume gain of at least 20 dB above the ambient level shall be user selectable. A function shall be provided to automatically reset the volume to the default level after every use.	Not Applicable	
g) Color coding shall not be used as the only means of conveying information, indicating an action, prompting a response, or distinguishing a visual element.	Supports with Exceptions	An audible “Beep” is heard as an alternative means of indicating an action or conveying information.
h) When a product permits a user to adjust color and contrast settings, a range of color selections capable producing a variety of contrast shall be provided.	Supports	To increase perception the user can adjust the contrast levels across a variety of settings.
i) Products shall be designed to avoid causing the screen to flicker with a frequency greater than 2 Hz and lower than 55 Hz.	Supports	The screen flickers at a frequency greater than 2 Hz and lower than 55 Hz.
j) (1) Products which are freestanding, non-portable, and intended to be used in one location and which have operable controls shall comply with the following: The position of any operable control shall _____ at the maximum be determined with respect to a vertical plane, which is 48 inches in length, centered on the operable control, and at the maximum protrusion of the product with the 48 inch length.	Supports	We conform to this provision and meet all reach standards.

VOLUNTARY PRODUCT ACCESSIBILITY TEMPLATE

Criteria	Supporting Features	Remarks/Explanations
j) (2) Products which are freestanding, non-portable, and intended to be used in one location and which have operable controls shall comply with the following: Where any operable control is 10 inches or less behind the reference plane, the height shall be 54 inches maximum and 15 inches minimum above the floor.	Supports	We conform to this provision and meet all reach standards.
j) (3) Products which are freestanding, non-portable, and intended to be used in one location and which have operable controls shall comply with the following: Where any operable control is more than 10 inches and not more than 24 inches behind the reference plane, the height shall be 46 inches maximum and 15 inches minimum above the floor.	Supports	We conform to this provision and meet all reach standards.
j) (4) Products which are freestanding, non-portable, and intended to be used in one location and which have operable controls shall comply with the following: Operable controls shall not be more than 24 inches behind the reference plane.	Supports	We conform to this provision and meet all reach standards.

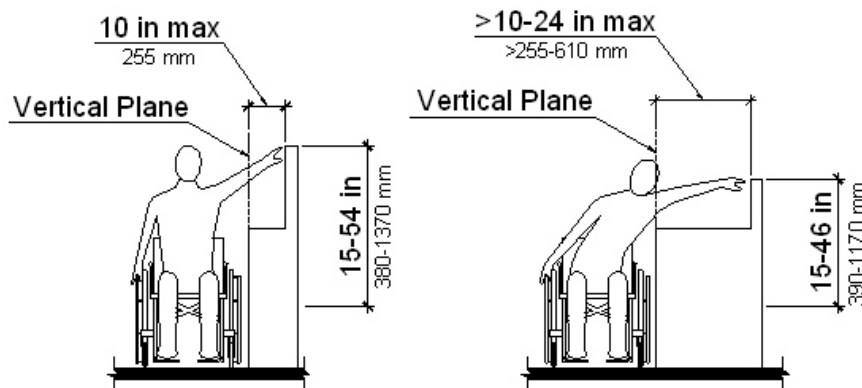

Height of Operable Control Relative to the Vertical Plane

Figure 2

VOLUNTARY PRODUCT ACCESSIBILITY TEMPLATE

Section 1194.31 Recommended Functional Performance Criteria		
Criteria	Supporting Features	Remarks/Explanations
a) At least one mode of operation and information retrieval that does not require user vision shall be provided, or support for Assistive Technology used by people who are blind or visually impaired shall be provided.	Supports	Audible (beep) and tactile (raised dash) controls are provided to assist with operation and information retrieval.
b) At least one mode of operation and information retrieval that does not require visual acuity greater than 20/70 shall be provided in audio and enlarged print output working together or independently, or support for Assistive Technology used by people who are visually impaired shall be provided.	Supports	Audible (beep) and tactile (raised dash) controls are provided to assist with operation and information retrieval.
c) At least one mode of operation and information retrieval that does not require user hearing shall be provided or support for Assistive Technology used by people who are deaf or hard of hearing shall be provided.	Not Applicable	
d) Where audio information is important for the use of a product, at least one mode of operation and information retrieval shall be provided in an enhanced auditory fashion, or support for assistive hearing devices shall be provided.	Not Applicable	
e) At least one mode of operation and information retrieval that does not require user speech shall be provided, or support for Assistive Technology used by people with disabilities shall be provided.	Not Applicable	
f) At least one mode of operation and information retrieval that does not require fine motor control or simultaneous actions and that is operable with limited reach and strength shall be provided.	Not Applicable	

VOLUNTARY PRODUCT ACCESSIBILITY TEMPLATE

Section 1194.41
Information Documentation and Support

Criteria	Supporting Features	Remarks/Explanations
a) Product support documentation provided to end-users shall be made available in alternate formats upon request, at no additional charge.	Supports	Upon request user documentation will be made available in alternative formats (audio, electronic, printed).
b) End-users shall have access to a description of the accessibility and compatibility features of products in alternate formats or alternate methods upon request, at no additional charge.	Supports	Upon request user documentation will be made available in alternative formats (audio, electronic, printed).
c) Support services for products shall accommodate the communication needs of end-users with disabilities.	Supports	Upon request support services will be provided in alternative formats (on-site, electronically, telephone).